

Stadiolnsieme

2024

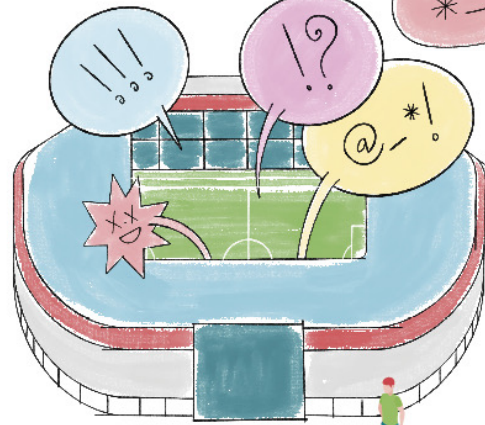

COMUNE di EMPOLI



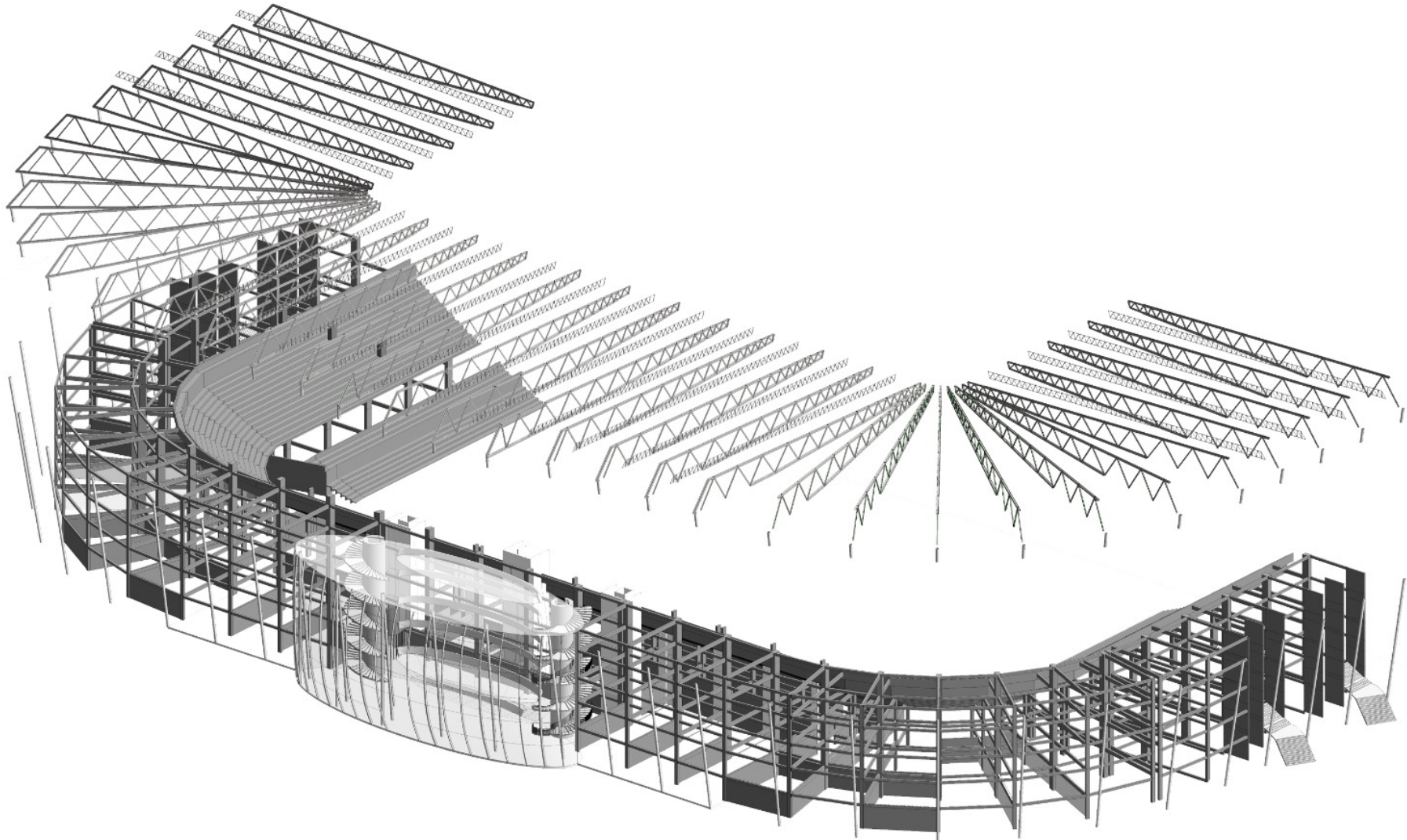

VISTA STRUTTURALE DELLA TRIBUNA OVEST



Stadiolnsieme 2024

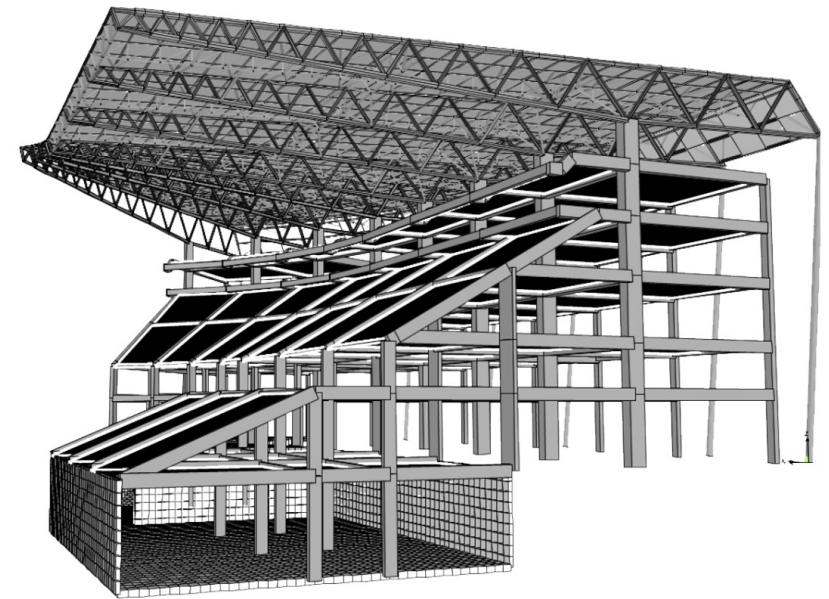
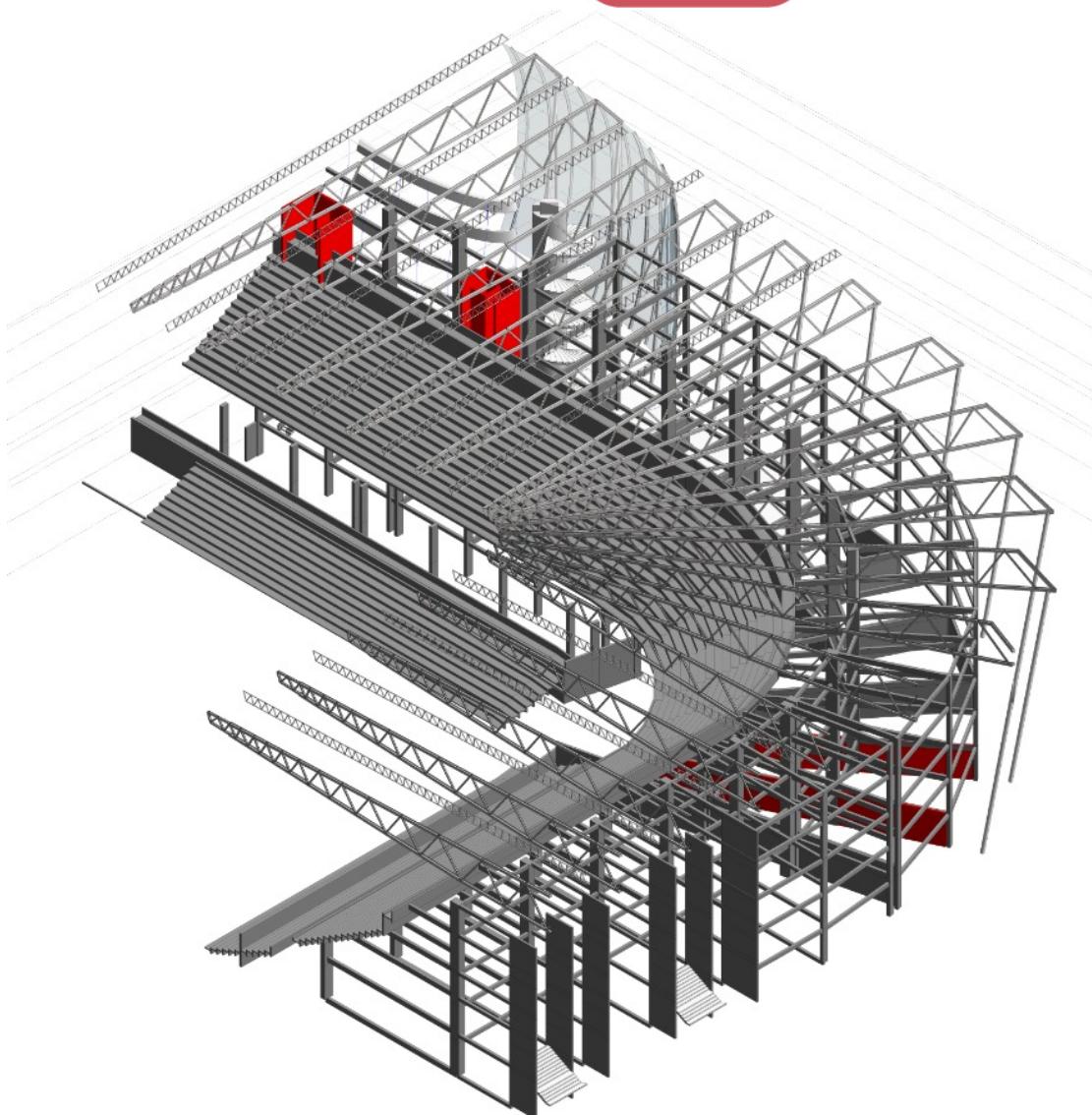

SEZIONE TRIBUNA OVEST CENTRALE



VISTA STRUTTURALE ESTERNA
TRIBUNA OVEST LATERALE



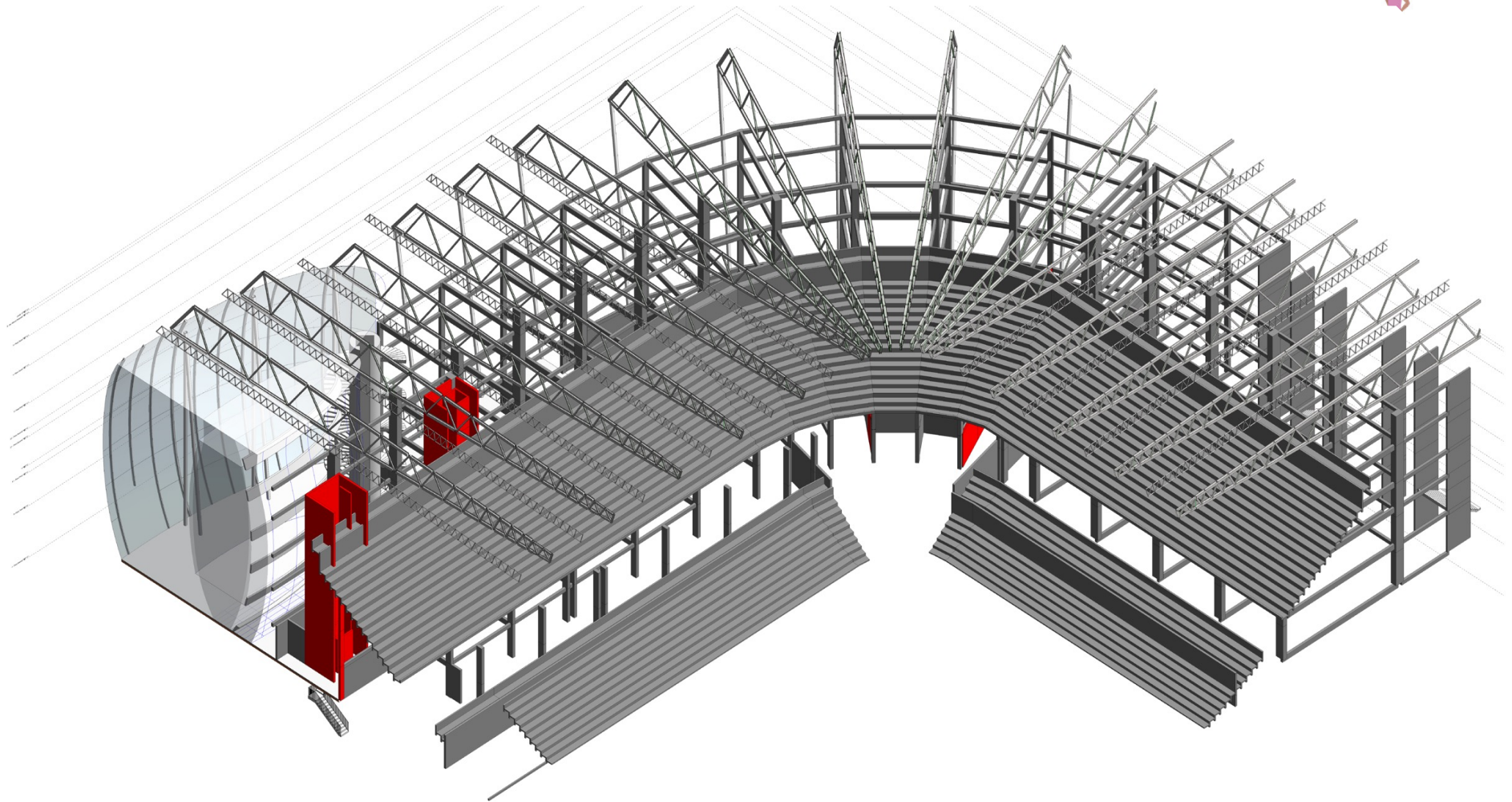

VISTA STRUTTURALE INTERNA DAL CAMPO TRIBUNA OVEST LATERALE



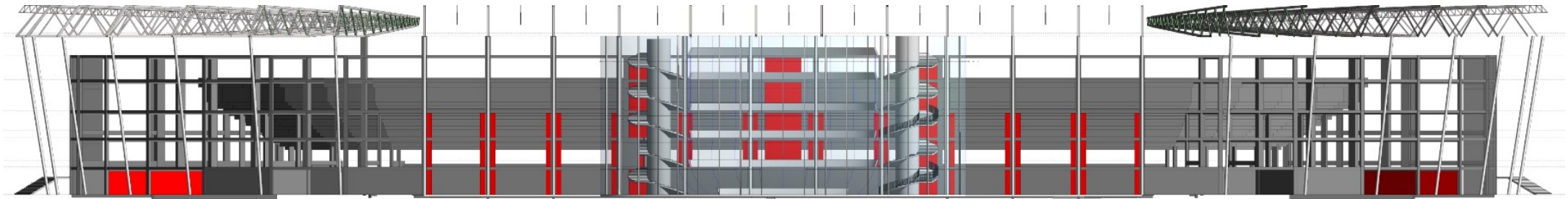

VISTA STRUTTURALE ESTERNA TRIBUNA OVEST



Stadiolnsieme 2024

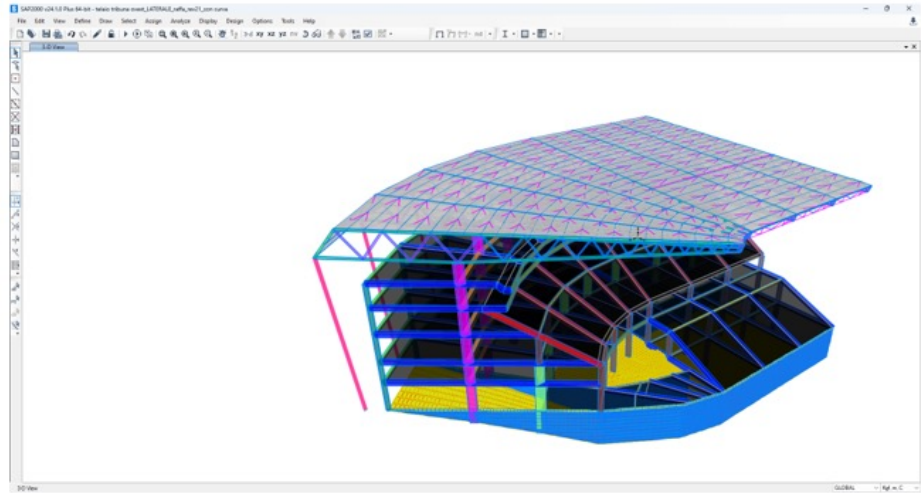
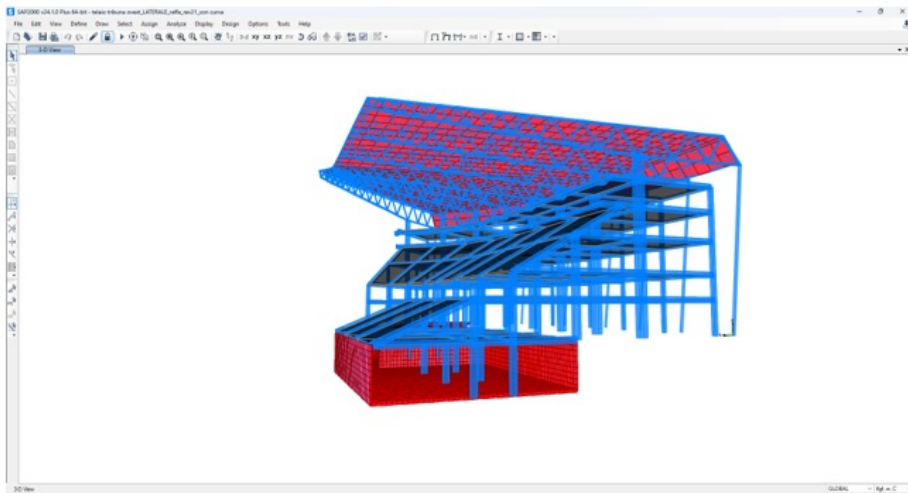

Vista estrusa

Modello - vista estrusa

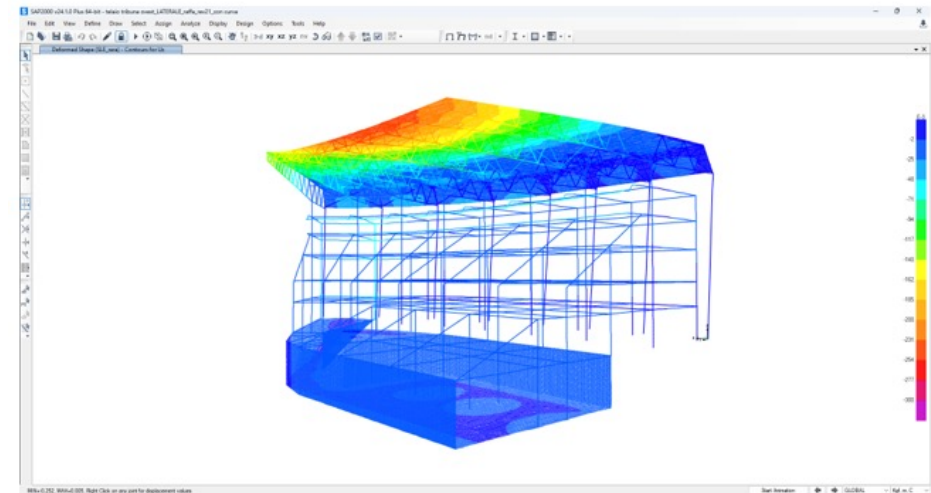
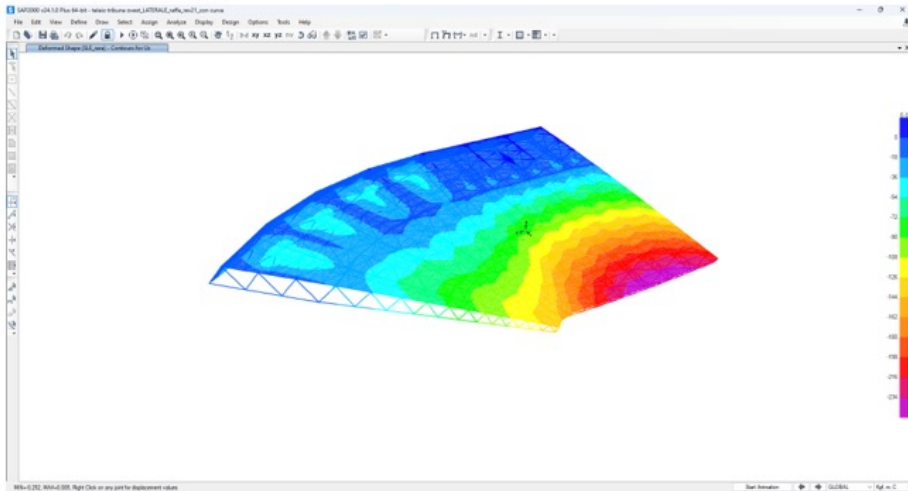

Deformata solo copertura - combinazione SLE_rara

Deformata - combinazione SLE_rara



COMUNE di EMPOLI

Stadiolnsieme 2024

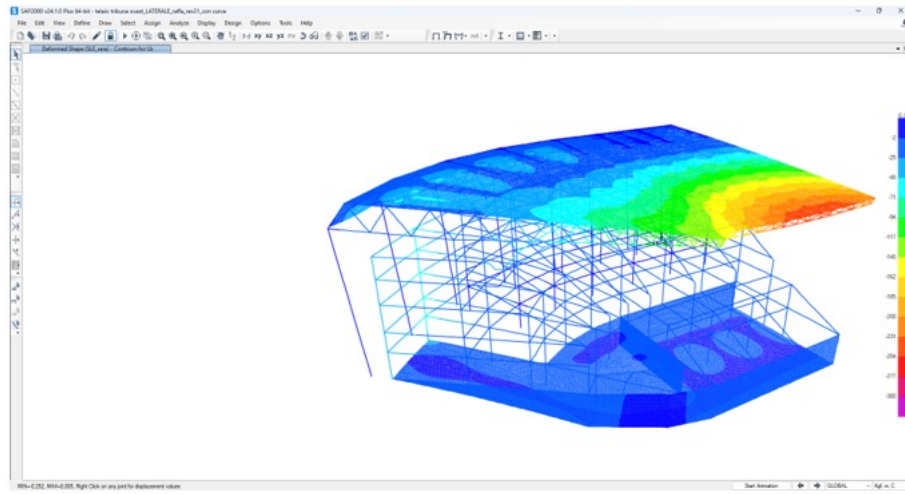

Deformata - combinazione SLE_rara

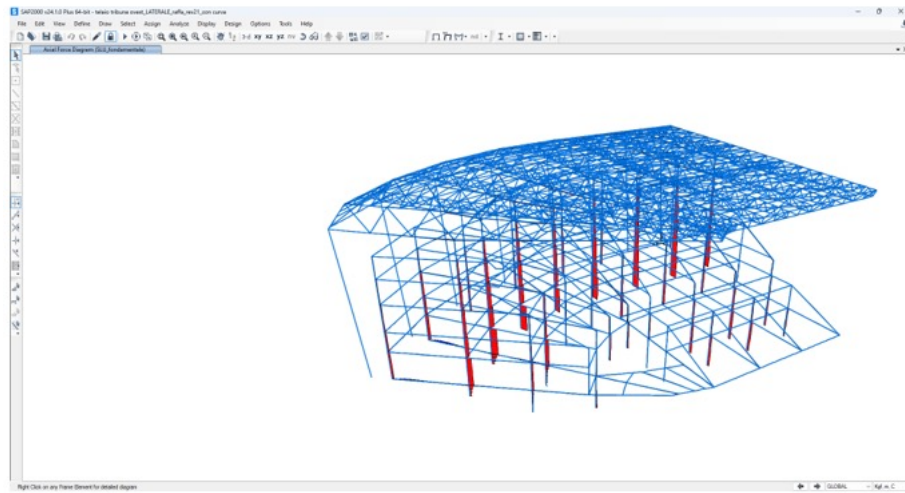

Sforzo normale – combinazione di carico SLU_fondamentale

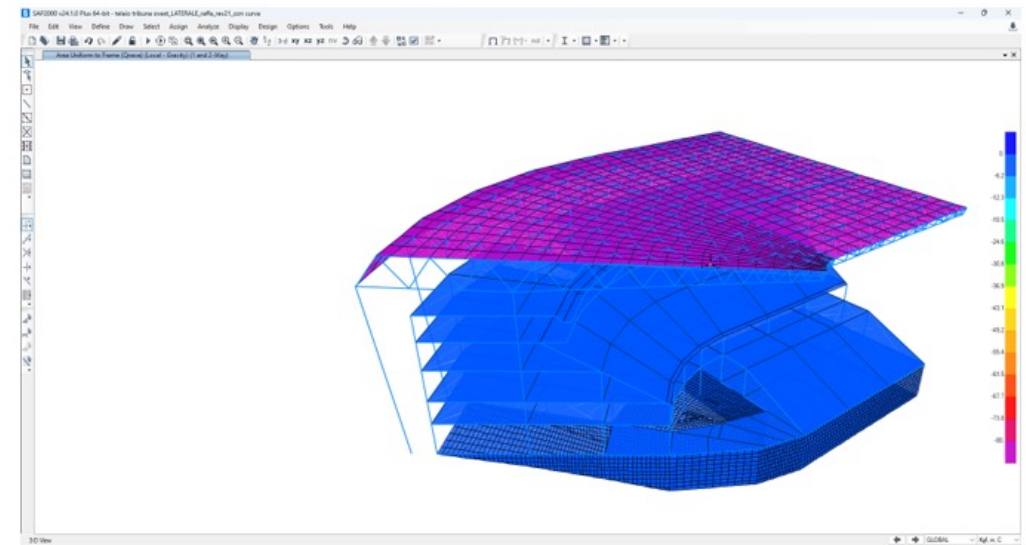

Carico neve



COMUNE di EMPOLI

StadiolInsieme **2024**



Grazie per la cortese attenzione



COMUNE di EMPOLI

Stadioliinsieme **2024**

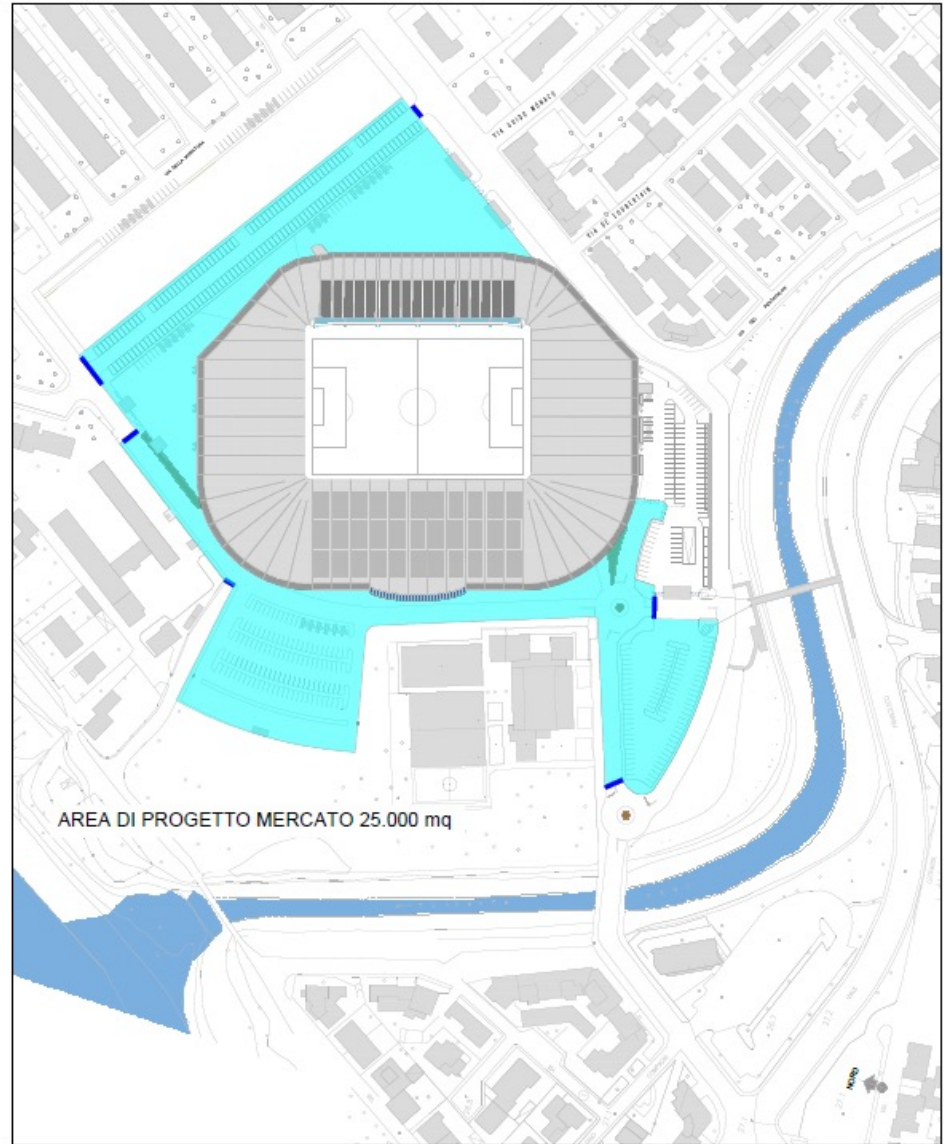
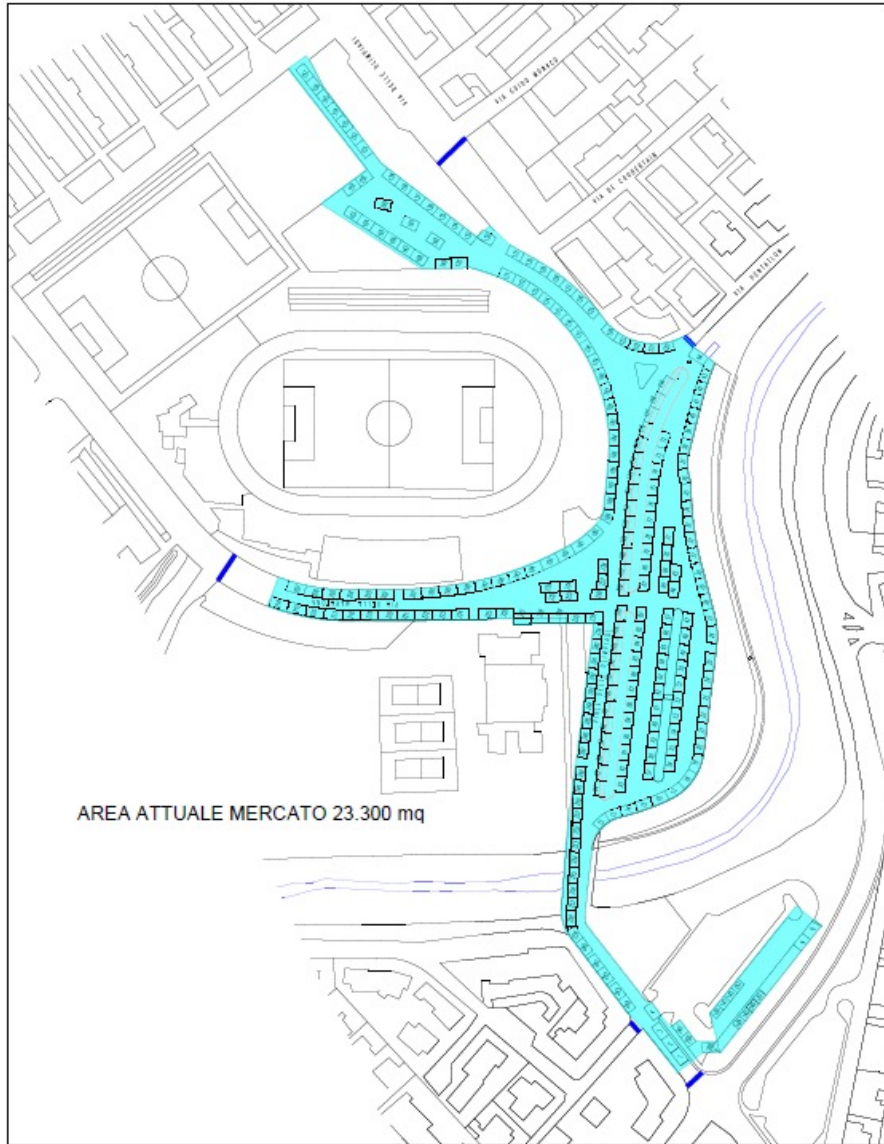

AREE PER MERCATO SETTIMANALE



COMUNE di EMPOLI

Stadiolnsieme 2024

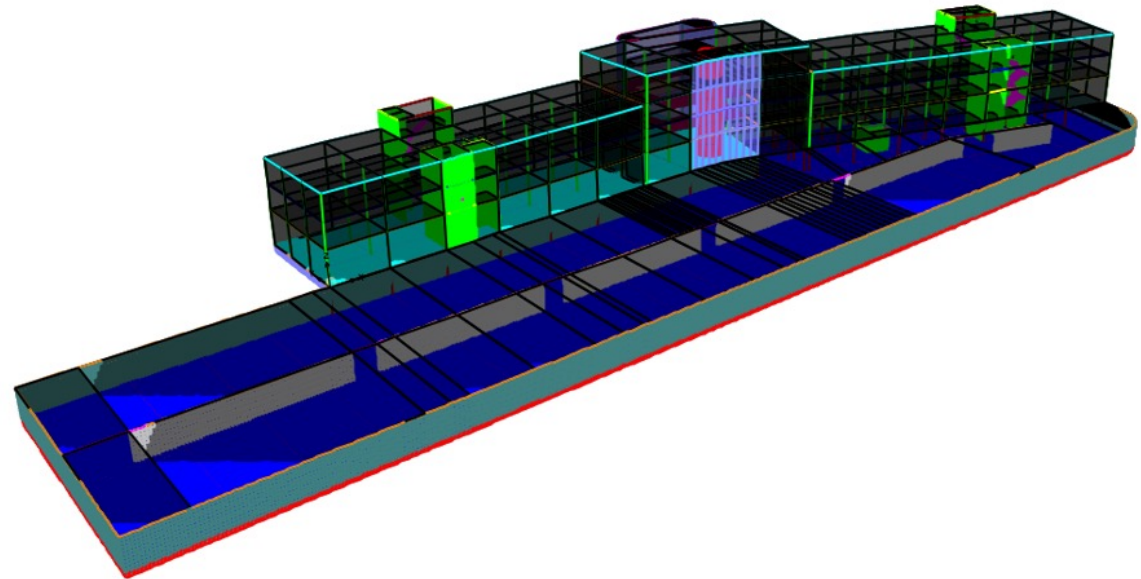

NUOVO HOTEL



COMUNE di EMPOLI

Stadiolnsieme 2024



Figura 12-distribuzione dei carichi permanenti strutturali G1_blocco1



Figura 18-distribuzione dei carichi permanenti strutturali G1_blocco 2

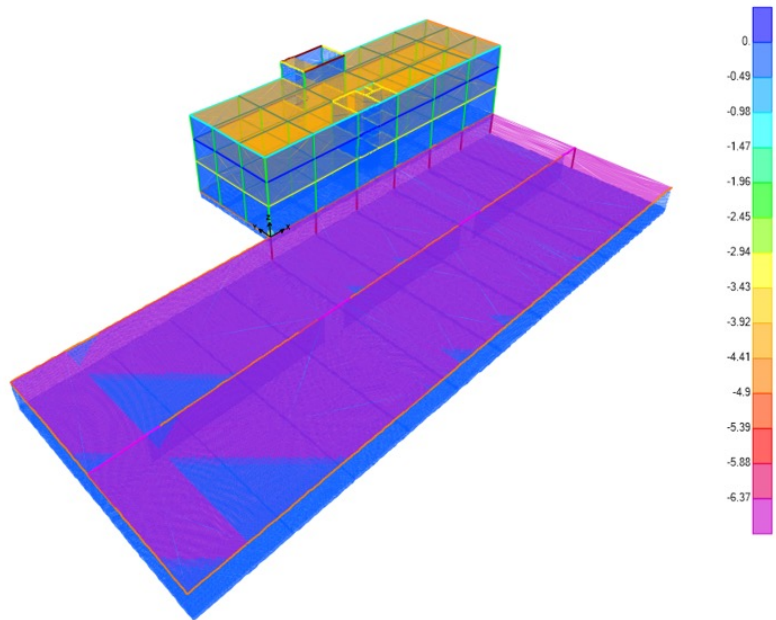

Figura 24-spinta del terreno QT_blocco 2

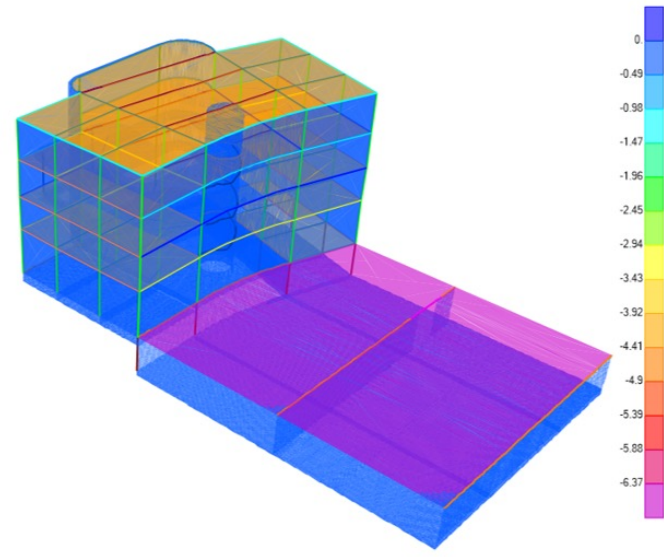

Figura 25-distribuzione dei carichi permanenti strutturali G1_blocco3



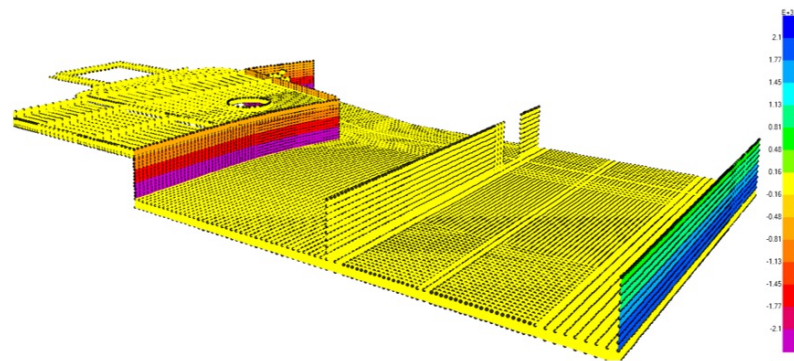

VISTE STRUTTURALI HOTEL

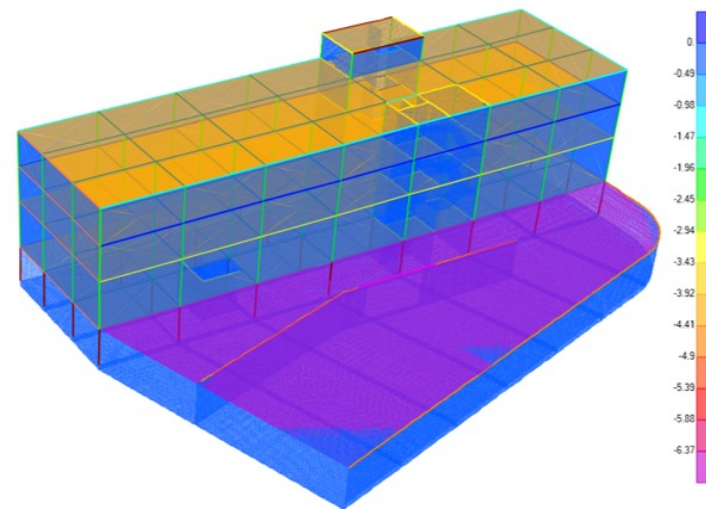
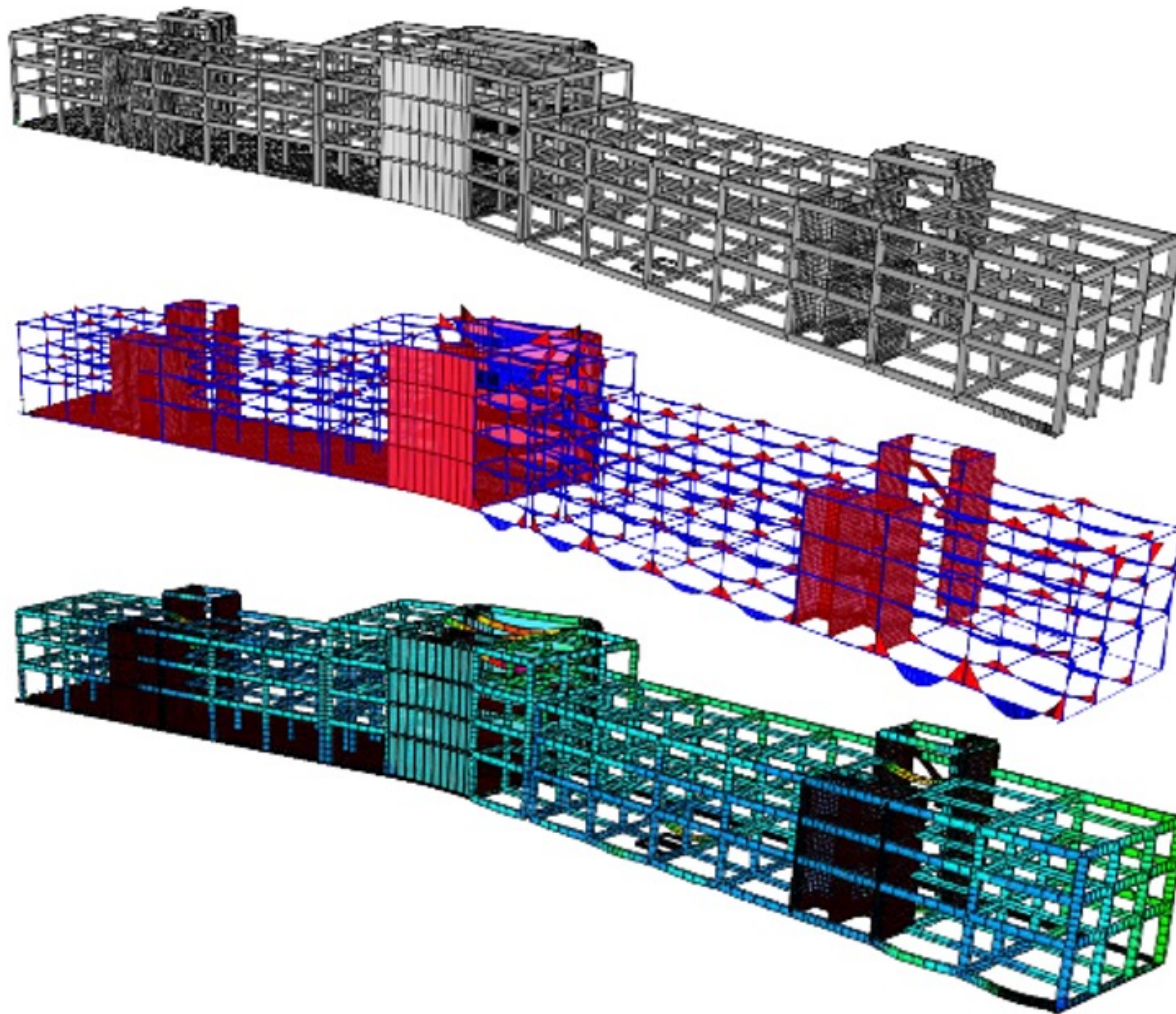

COMUNE di EMPOLI